

Commercial Marine Generator Set

Generator Features

- Engine is Environmental Protection Agency (EPA) Tier II compliant
- Superior Kohler Fast-Response™ PMG generator ends
- Remote control connector
- Class H insulation with tropical overcoat
- Reconnectable voltage
- One- or three-phase reconnectable alternator
- Voltage regulation of 2%
- Frequency regulation of 0.5%

Optional Accessories

- Power takeoff (PTO)
- Isolated ground system (12- or 24-volt)
- Circuit breakers

Optional Agency Type Approvals

- Lloyd's Register
- Det Norske Veritas (DNV)
- American Bureau of Shipping (ABS)
- Bureau Veritas (BV)

Generator Weights and Dimensions

Generator Set	
Weight, kg (lb.)	
Wet	1420 (3130)
Dry	1370 (3020)
Length, mm (in.)*	2138 (84.18)
Width, mm (in.)	811 (31.91)
Height, mm (in.)	956 (37.63)

* Add 181 mm (7.14 in.) to the unit's length if the unit has the 12/24-volt electric clutch PTO option.

See the drawings on the last page for detailed dimensions.

Generator Ratings (Prime 90°C/50°C)

Model Series	Voltage	Hz	Amps	Rated kW/kVA	Ph
99EOZC	120/208	60	343	99.0/124.0	3
	120/240	60	298	99.0/124.0	3
	127/220	60	325	99.0/124.0	3
	139/240	60	298	99.0/124.0	3
	277/480	60	149	99.0/124.0	3
80EFOZC	110/190	50	304	80.0/100.0	3
	110/220	50	262	80.0/100.0	3
	220/380	50	152	80.0/100.0	3
	230/400	50	144	80.0/100.0	3
	240/416	50	139	80.0/100.0	3

RATINGS: Ratings per ISO 3046, ISO 8528-1, and Kohler ISO rating guideline 2.14. Obtain technical information bulletin (TIB-101) on ratings guidelines for complete ratings definitions.

Availability is subject to change without notice. Kohler Co. reserves the right to change the design or specifications without notice and without any obligation or liability whatsoever. Contact your local Kohler generator set distributor for availability.

10% overload capacity one hour in twelve hours.



Application Data

Engine

Engine Specifications	60 Hz	50 Hz
Type	Inline, 4-cycle	
Number of cylinders	6	
Firing order	1-5-3-6-2-4	
Aspiration	Turbocharged	
Displacement, L (cu. in.)	6.8 (414)	
Bore and stroke, mm (in.)	106 x 127 (4.19 x 5.00)	
Compression ratio	17.0:1	
Combustion system	Direct injection	
Rated rpm	1800	1500
Maximum power at rated rpm, HP	148	119
Cylinder block material	Cast iron	
Cylinder head material	Cast iron	
Piston rings	2 compression/1 oil	
Crankshaft material	Forged steel	
Connecting rod material	Forged steel	
Governor type	Electronic isochronous	

Engine Electrical

Engine Electrical System	60 Hz	50 Hz
Battery, voltage	12- or 24-volt spec	
Battery, charging (12 volt)	65 amp	
Battery, charging (24 volt)	40 amp	
Battery, recommendation (minimum, 12 volt)	800 CCA	
Starter motor	Gear-reduction type	

Cooling

Cooling System	60 Hz	50 Hz
Capacity, L (U.S. qt.) (approx.)	19 (20)	
Cooling type	Heat exchanger	
Seawater pump type	John Deere gear driven	
Seawater pump suction lift, maximum, m (ft.)	3.0 (10.0)	
Heat rejected to cooling water at rated kW, wet exhaust, kW (Btu/min.)	103 (5863)	80 (4554)
Engine water pump flow, Lpm (gpm)	125 (33)	116 (31)
Seawater pump flow, Lpm (gpm)	84 (22)	70 (18)

Fuel

Fuel System	60 Hz	50 Hz
Fuel recommendation	Diesel fuel specified to EN 590 or ASTM D975	
Fuel shutoff solenoid	Electric	
Fuel injection pump	Stanadyne DE10, electronic	
Fuel pump priming	Manual	
Maximum recommended fuel lift, m (ft.)	3.0 (10.0)	

Lubrication

Lubricating System	60 Hz	50 Hz
Oil pan capacity with filter, L (U.S. qt.)	24.6 (26)	
Type	Pressure	

Operation Requirements

Air Requirements	60 Hz	50 Hz
Engine combustion air requirements, m ³ /min. (cfm)	10.7 (378)	6.9 (244)
Max. air intake restriction, kPa (in. H ₂ O)	6.25 (25)	6.25 (25)
Cooling air required for generator set at 50°C (122°F) ambient, m ³ /min. (cfm)	30.5 (1000)	25.9 (850)
Exhaust flow, m ³ /min. (cfm)	24 (848)	16 (558)
Exhaust temp., °C (°F)	396 (745)	411 (722)
Max. allowed exhaust backpressure, kPa (in. H ₂ O)	7.5 (30)	7.5 (30)

Fuel Consumption	60 Hz	50 Hz
Diesel, Lph (gph) at % load		
100%	29.4 (7.8)	22.4 (5.9)
75%	22.9 (6.0)	16.9 (4.5)
50%	15.5 (4.1)	11.8 (3.1)
25%	9.2 (2.4)	6.7 (1.8)

Engine Features

- One-side serviceability of fuel system, lubrication system, and air cleaner
- Low oil pressure cutout
- High water temperature cutout
- Loss of coolant cutout
- Overcrank cutout
- Belt guard
- Optional oil pressure gauge, water temperature gauge, and battery voltage gauge
- Disposable oil filter
- Extended oil drain
- PTO options: 12- or 24-volt electric clutch

Controller Features

- Rubber mounted to isolate vibration
- Safety shutdowns
 - Engine overheating
 - Low oil pressure
 - Overcrank
 - Low seawater pressure
- Safety shutdown lamp
- Shutdown reset switch
- Terminal strip connection for remote panel harness
- Hourmeter for scheduling maintenance
- 4-20 mA or 0-5 VDC voltage biasing input
- Start/stop switch

Controller

Decision-Maker™ 3+ Controller Features

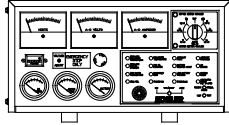

- Type: 16-light microprocessor (NFPA 110, level 1)
- Power source, with circuit protection: 12-volt DC
- Panel lamps (2)
- Analog Meters:
 - AC meters, 89 mm (3.5 in.) 2% full-scale accuracy on voltmeter and ammeter, 0.5% full-scale accuracy on frequency meter
 - DC meters, 51 mm (2 in.), volts, engine water temperature, oil pressure
 - Running time meter
- Switches and Controls:
 - Alarm horn and silencing switch
 - Cyclic cranking
 - Engine cooldown timer, 0 minute (5 minute selectable)
 - Front-mounted voltage-adjusting rheostat $\pm 5\%$
 - Lamp-test switch
 - Local emergency stop button switch (optional)
 - Meter-phase selector switch, 7-position
 - Overvoltage protection shutdown
 - Prime power mode
 - Run/off-reset/auto switch (engine start), local/remote two-wire
- Fault and Condition Lamps:
 - Auxiliary fault (red)
 - Auxiliary prealarm (yellow)*
 - Battery charger fault (red)*
 - Emergency stop (red)*
 - Generator switch not-in-auto (red)
 - High engine temperature safety shutdown (red)
 - Low battery voltage (red)*
 - Low coolant level shutdown (auxiliary)
 - Low fuel (red)*
 - Low oil pressure safety shutdown (red)
 - Low water temperature (red)*
 - Overcrank safety shutdown (red)
 - Overspeed safety shutdown (red)
 - Prealarm high engine temperature (yellow)*
 - Prealarm low oil pressure (yellow)*
 - System ready (green)

* Requires an optional kit or a user-provided device for lamp to function.

Alternator Specifications

Alternator Specifications

Specifications	Fast-Response™ Generator
Manufacturer	Kohler
Type	4-pole, rotating-field
Exciter type	Brushless, permanent-magnet, Fast-Response™
Number of leads	12, reconnectable
Voltage regulator	Solid state, volts/Hz
Insulation: NEMA MG1-1.66	
Material	Class H
Temperature rise	90°C
Bearing: number, type	1, sealed
Coupling	Flexible disc
Amortisseur windings	Full
Voltage regulation, no load to full load	2%
One-step load acceptance per NFPA 110	100% of rating
Peak motor starting kVA—4S11	460 (60 Hz), 350 (50 Hz)

Alternator Features

- The generator complies with NEMA, IEEE, and ANSI standards for temperature rise.
- The alternator uses a permanent-magnet, Fast-Response™ excitation system.
- The alternator has a two-thirds pitch stator and skewed rotor.
- The generator has a solid-state, volts-per-hertz voltage regulator.
- The brushless, synchronous generator is broadrange and reconnectable.
- The windings have a tropical insulation suited for harsh environments. The tropical insulation consists of an epoxy overcoat which provides additional abrasion resistance and protection for use in high-humidity marine environments.
- The generator sustains short-circuit current up to 300% of the rated current for up to 10 seconds.

Accessories/Options

- Electric front clutch PTO (12- or 24-volt)
- Line circuit breaker
- Decision-Maker™ 3+ controller
- Remote control panel
- Siphon break
- Isolated ground system (12- or 24-volt)
- Remote connection/extension harness
- Safeguard breaker
- Oil level indicator (high/low)
- Low coolant level indicator

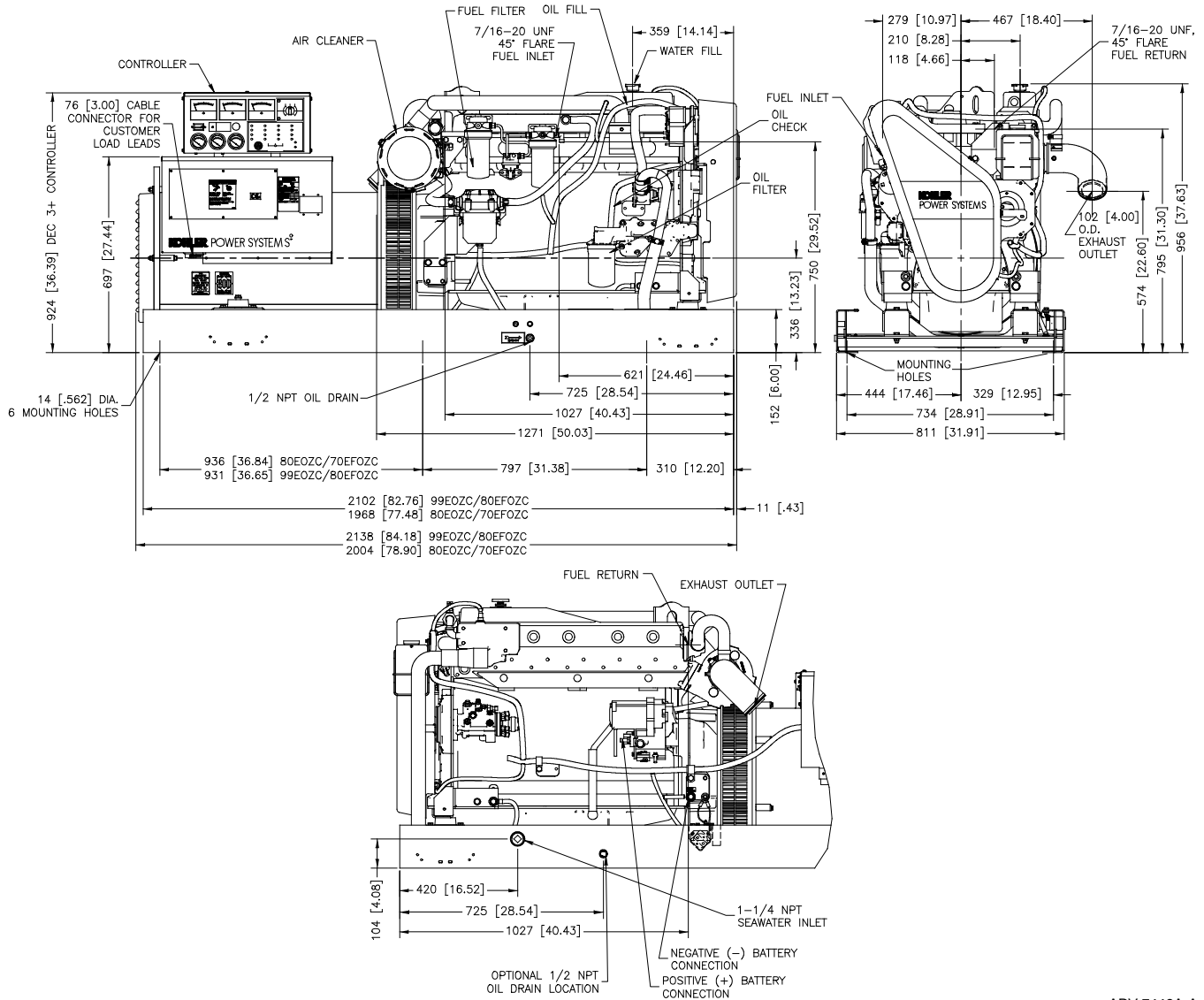

ADV-7443A-A

DISTRIBUTED BY:

NOTE: Dimensions are shown in mm [in.].

NOTE: This drawing is provided for reference only and is not intended for installation planning. Contact your local distributor for more detailed information.

© 2007, 2008, 2009, and 2012 by Kohler Co. All rights reserved.